

AcuTrac[®] 22 Pro

Dual Satellite Tracking Meter
With Self-Contained Battery

From **PERFECT 10**
SATELLITE DISTRIBUTING

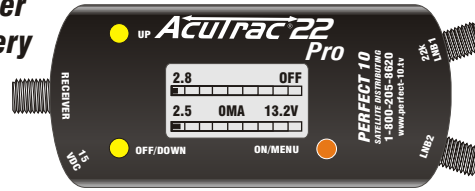

Included in this Kit

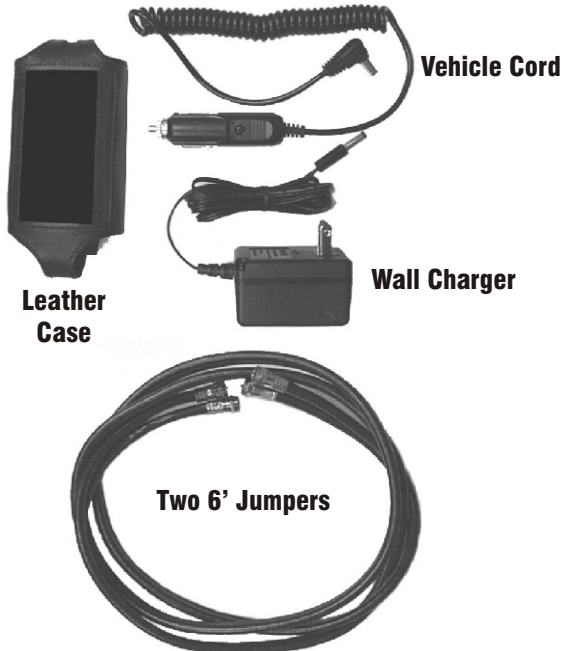

Input Frequency:	900-2200 MHz
Input Level:	20-100 dB μ V
Through Loss:	3.5 db
Input Impedance:	75 Ohm "F" connector
Output Impedance:	75 Ohm "F" connector
Measuring Method:	LCD display with full text graphics Pitch tone on audio speaker
Power Supply:	Internal 8.4 V Ni MH battery <u>or</u> from satellite receiver through coaxial cable.
Power Consumption:	40 mA 50 mA utilizing audio speaker
Overload Protection:	600mA LNBF current draw limiter (Meter indicates "Over Current")
Input Voltage Tolerance:	Receiver up to + 28vDC max.
Battery Performance:	Fully charged @ 70° F ~ 30 minute operation when connected to a "Phase III" LNBF.

Overview

The AcuTrac22 Pro is designed to be an aid in aligning satellite antennas so they can provide maximum performance. Please be aware of the fact that there are numerous satellites which will cause the AcuTrac22 Pro to respond with a signal reading. The installer must select the correct satellite(s) for alignment. It is quite easy to select the wrong satellite and find that the satellite receiver indicates "No Signal". The software provided with the satellite receiver can provide the elevation and azimuth of the satellite(s) desired. With this information in-hand and a good compass you can point the antenna in the proper direction. Then, with the aid of the AcuTrac22 Pro, the performance of the antenna can be maximized by watching the tuning bar and digital strength readings.

Please take time to read this instruction manual so you will be familiar with the capabilities of the AcuTrac22 Pro.

Charge the Battery

The AcuTrac22 Pro can be powered by the internal battery or from a satellite receiver. We suggest you charge the internal battery before attempting to use the meter as, in most field situations, you will probably be relying on the internal power.

To charge the battery, plug the wall charger or vehicle charger into the "15VDC socket on the meter. The LCD display will indicate charging is in process with approximately 14 hours to go on the cycle.

NOTE: If the internal battery is 'dead', connecting the wall charger or vehicle charger cord will only begin the battery charge cycle, this will not power the meter.

To use a satellite receiver for power, or to power the meter when the battery is discharged, plug the AcuTrac22 Pro into the coax between the receiver and the LNBF, the AcuTrac22 Pro will power up immediately. However, the satellite receiver will not charge the internal battery. Charging must be done with the wall charger or vehicle cord.

Startup

After the battery has charged, press the **“ON/MENU”** button. The AcuTrac22 Pro is immediately ready to begin antenna alignment. The signal strength (when connected to a dish) will be indicated by the bar graphs and in digits just above each bar graph. As you move the dish, you will see the increase and decrease in signal strength. The objective is to maximize the signal strength indicated on the bar graph(s) by minor azimuth, elevation and rotation adjustments of the dish. When you have maximized the readings, lock the dish mount bolts and re-attach the LNBFs to the switches or cables provided with the antenna. Then check your efforts with the satellite receiver.

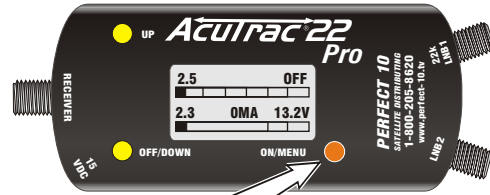

Press to use the internal battery

Connections

Single or Dual LNBFs

You can connect the AcuTrac22 Pro to a single or a dual LNBF and read the satellite strength on either the top or bottom bar depending on which connection (LNB1 or LNB2) is attached.

Read the Satellite on the top bar



Or read the Satellite on the bottom bar

Phase III LNBF

Connect two jumpers to any of the four ‘F’ connections on the Phase III LNBF. Connections are not satellite-specific.

With the 22K tone “On” (see the menu selections on page 3), read the 119° satellite on the top bar and the 101° satellite on the bottom bar. Note the **‘22K’** text indication above the top bar.

Read the 119° Satellite on the top bar



Read the 101° Satellite on the bottom bar

Power demand over 600 mA will result in an “Over Current” indication.

Audible Tone

An audible tone is available if you would prefer listening to the AcuTrac22 Pro rather than trying to watch the digital readings or bar graph. The audible tone is selectable and applies to only one LNBF at a time.

To use the tone capability, start from the default signal sensing mode. (Right)

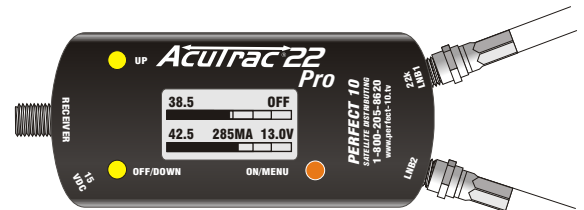

Press the **“OFF/DOWN”** button once. The tone will begin and the letter ‘T’ will appear above the top bar graph. This indicates that the tone applies to the top LNB(1) reading.

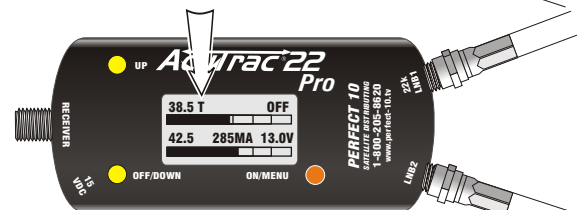

To apply the tone to the bottom LNB(2), press the **“OFF/DOWN”** button once more. The ‘T’ will appear above the bottom bar graph and the tone will apply to that LNB. To cancel the tone, press the **“OFF/DOWN”** button one more time.

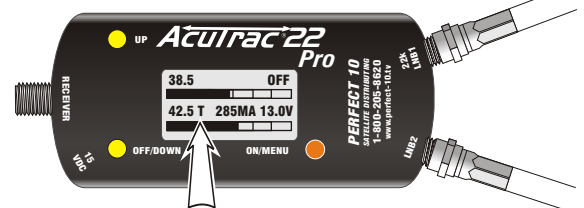

The Menu

The AcuTrac22 Pro can provide much more information about your satellite system. To access the expanded menu area, press the “**ON/MENU**” button. The screen illustrated (right) will appear and provide a very detailed range of tests and adjustments. The menu map as well as details about what each function can do for you is listed in this manual. Press the “**UP**” or “**OFF/DOWN**” button to scroll the arrowhead pointer up and down through the menu.



VIEW SIGNAL

This is the screen you will see when you first turn the AcuTrac22 Pro on. These bars indicate the general signal strength, voltage and current draw in mA of all connected devices. If desired, you can look at only one LNB by pressing the “**UP**” button. Press the “**UP**” button again to look at only the second LNB, one more press of the “**UP**” button takes you back to both LNBS.

VIEW RECEIVER

Displays the voltage provided by the satellite receiver or battery. Indicates the total current draw in mA of all connected components. Also indicates if a 22kHz tone is being sent by a DirecTV® receiver. These readings verify the receiver operation. Also, using the receiver for power, you can measure voltage at the receiver and then at the end of the coax, this will help calculate the voltage loss through the coax cable.

Pressing the “**OFF/DOWN**” button brings up a second screen which displays the requested port number from an early model DishNetwork receiver.

22KHZ MODE

The AcuTrac 22 Pro has a built-in 22Khz tone generator which can be activated by this function. This allows you to control many typical switches (such as the DirecTV Phase III LNBF) and select two different LNBS at the same time. For example, you can look at the 119° satellite (if the 22KHZ tone is activated) on the top graph and 101° on the bottom bar graph simultaneously. If the 22KHZ is set OFF, the tone from a DirecTV receiver will NOT pass and the switch commands from a DishPro® receiver will be blocked. Note that the 22KHZ tone and DishPro switch commands can only be activated on LNB1 (top connection ONLY).

13/18V Selectable ONLY when satellite receiver is NOT connected.

You can select 18vDC as the output voltage sent from the battery to the LNBF. Be very frugal when selecting this higher voltage as the circuitry demands a lot more battery power. If the demand on the battery is high, the voltage will AUTOMATICALLY drop back to 13V.

NEW DISH CTRL

This item is hidden from view, you must press the “**OFF/DOWN**” button to scroll down to it. The NEW DISH CTRL feature allows you to control the DishPro switches. Specifically, Port 1, 2 and 3 on the DP34, or Port 1 and 2 on the DP21 can be selected as needed. Note that only the top connection (LNB1) on the AcuTrac Pro sends the switching commands. The bottom port (LNB2) can only “look” at Port #1 of either switch. This allows you to look at Port 1 on the bottom bar and Port 2 or Port 3 (DP34) on the top bar. See page 6 for a further explanation of this feature.

ATTEN

This attenuates (reduces) both the signal meter readings to lower numbers. Handy if the bar graph is maxed out. Note that the ‘A’ text is now displayed. To turn this feature off, go back to >ATTEN and select OFF.

SETUP

Setup takes you to a list of options as follows:

MAX HOLD This function superimposes a small bar at the end of the bar graph (signal strength) which keeps track of the maximum signal received. This can be turned on or off as needed. Your choice will remain in the memory.

LCD-CONTRAST Scroll down to “**DARKER**” or “**LIGHTER**”, then press the “**ON/MENU**” button repeatedly to darken or lighten graphics. Scroll back up to “**EXIT**” and press the “**ON/MENU**” button to save your selection in the memory.

AUTO OFF This sets the automatic timer to turn the AcuTrac22 Pro off when the battery is used for power. Scroll down to the setting you prefer and press the “**ON/MENU**” button to save the time you selected in the memory.

Menu Map

Press "ON/MENU"
Then scroll down with
the arrowhead selector

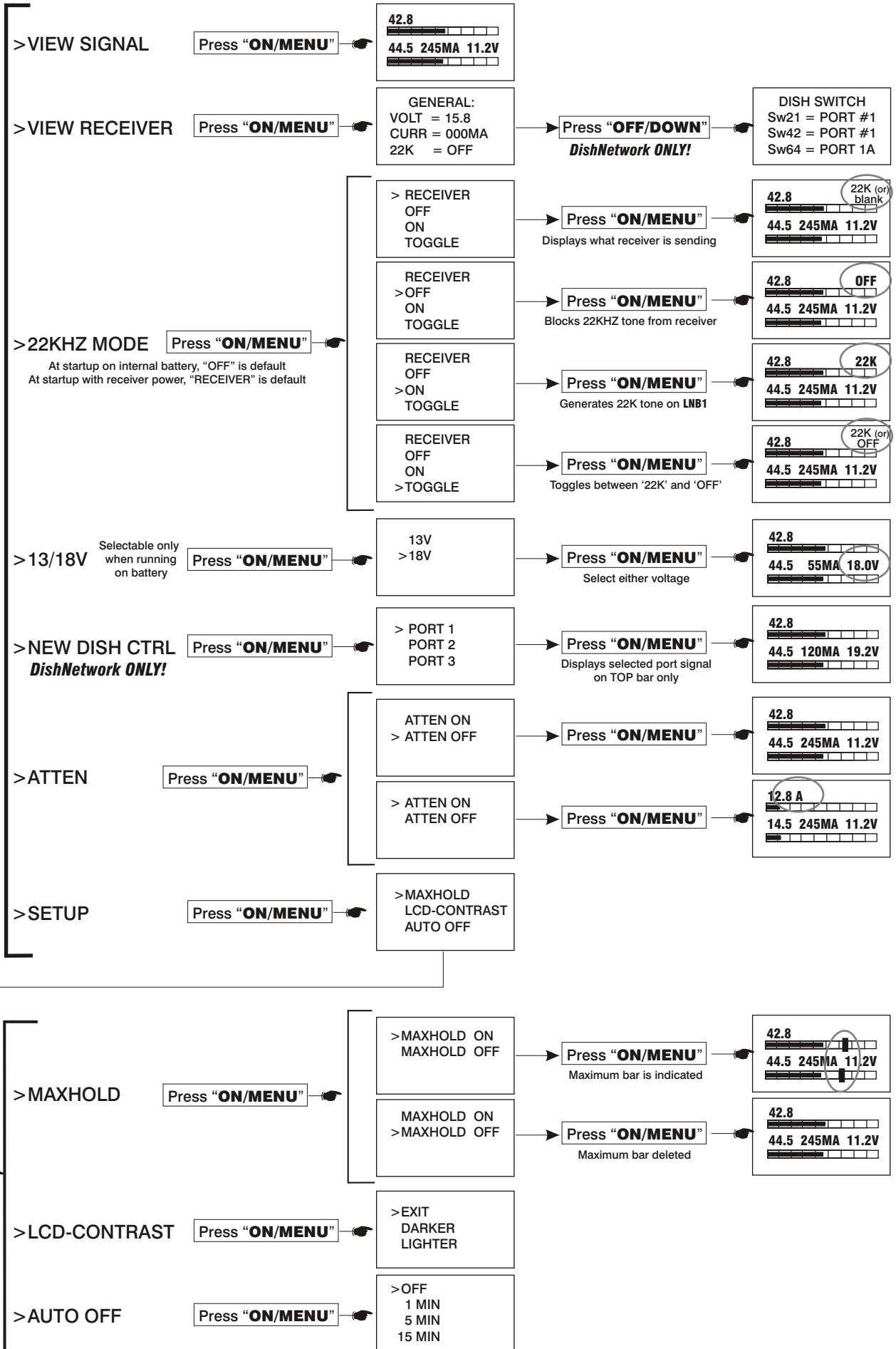

Receiver Video

Note that you must select only one LNB to receive video signals for a viewable picture. The AcuTrac 22 is effectively dividing it's attention to both ports LNB1 and LNB2 when both bar graphs are presented. This is perfect for dish alignment but interrupts the data stream to the receiver(s) and they will present no video in this mode.

If you want to check the video with the AcuTrac 22 in the line, press the “UP” button to select the LNB you would like to view. This illustration indicates that we have selected LNB1. The video data will now pass smoothly from LNB1 through the AcuTrac22 Pro and can be interpreted correctly by the satellite receiver.

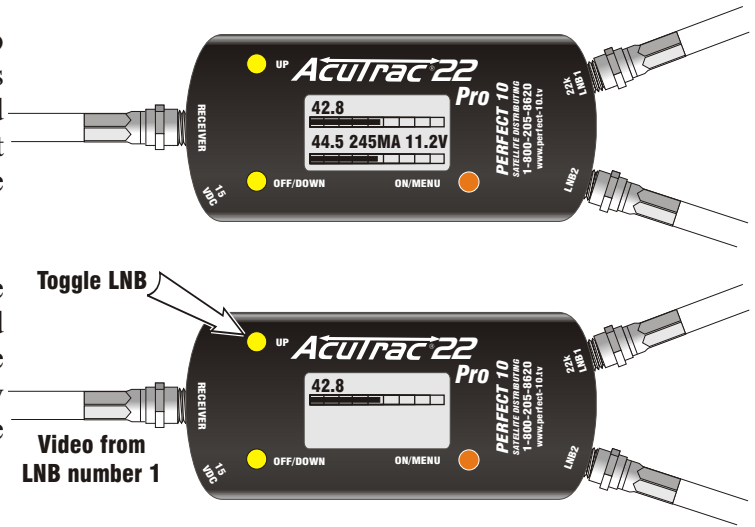

DishNetwork Info

Powered from the internal battery pack

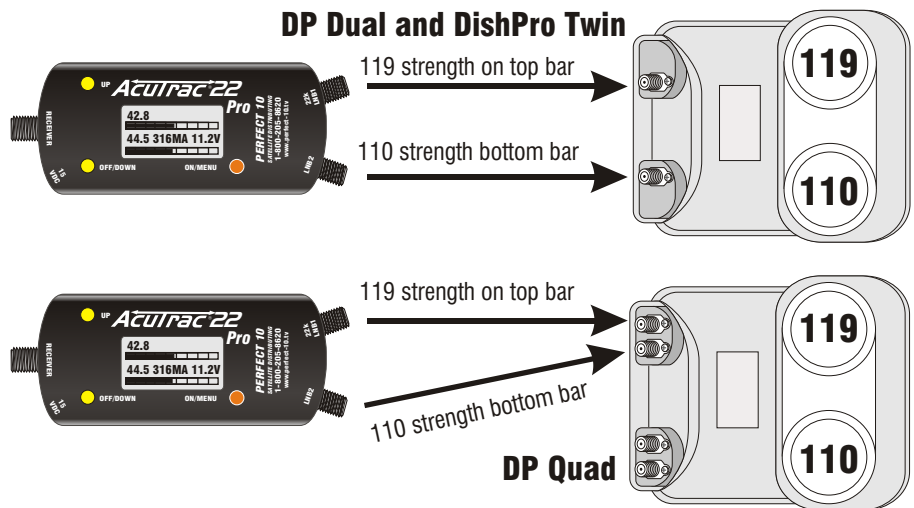

(or)

DP receiver is used for power

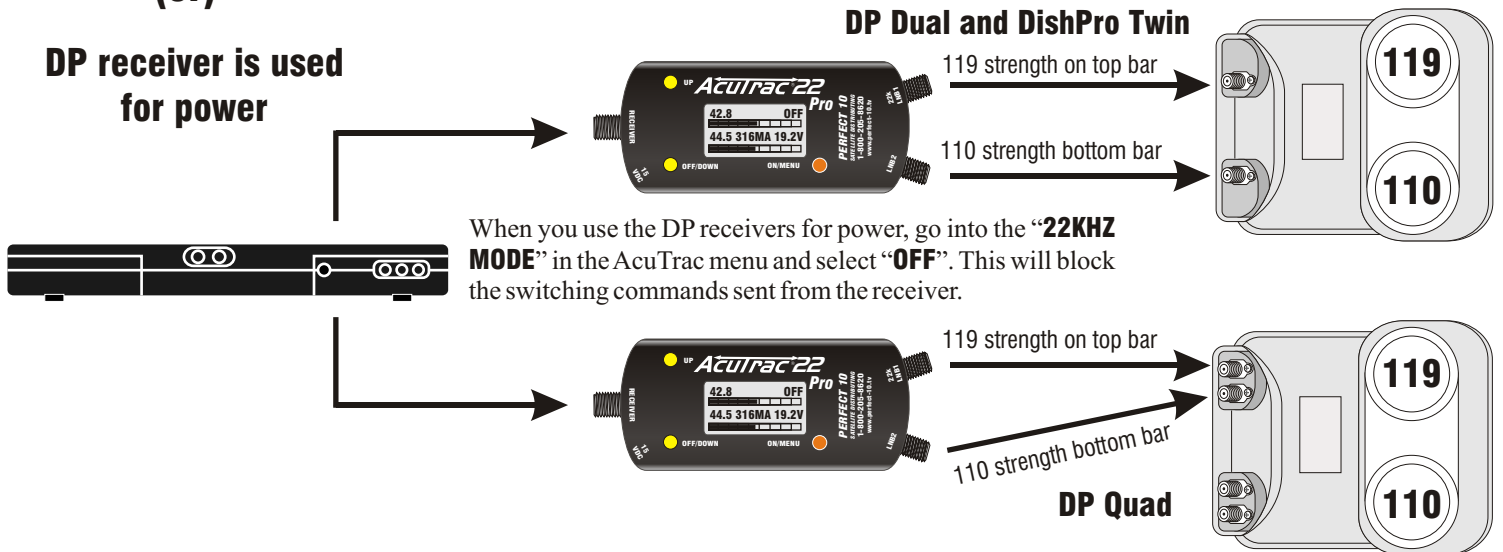

When you use the DP receivers for power, go into the “22KHZ MODE” in the AcuTrac menu and select “OFF”. This will block the switching commands sent from the receiver.

The DP receiver sends out a “switch” command whenever it is not locked on a satellite, obviously, this is the case if the antenna is not aligned yet. This command causes the dual or quad LNBF to switch from one output (say 110) to the other (say 119). When aligning the antenna, this can be pretty confusing so block the switch command in the AcuTrac by turning the 22KHZ “OFF” when a dual or quad LNBF is attached and a DP receiver is used for power.

The DP21 Switch

Note that the DP21 switch and the connected LNBFs draw more current than the internal battery can reliably provide; therefore, we suggest that you attach a DP receiver to the AcuTrac. The receiver will then supply the necessary constant power to the components.

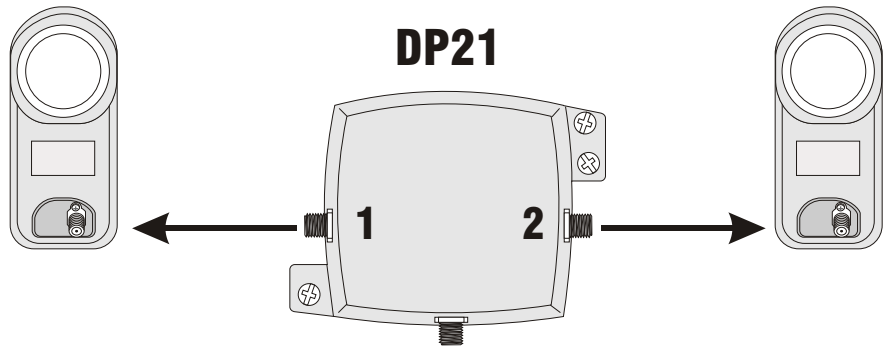

The DP34 Switch

When you use the DP receivers for power, go into the "**22KHZ MODE**" in the AcuTrac menu and select "**OFF**". This will block the switching commands sent from the receiver.

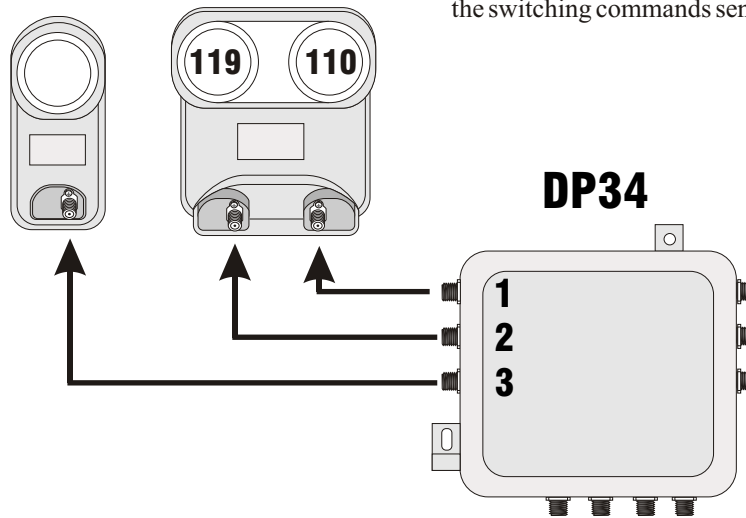

The DP34 and its components draw a considerable amount of current, typically in excess of 600 mA. Since this approaches the upper current limit of the AcuTrac, it is recommended that you use a DP receiver to power the hardware components (make this connection first). This will reduce the mA draw on the AcuTrac considerably. A second receiver may optionally be used to power the AcuTrac if the internal battery level is low in the meter.

The bottom bar of the AcuTrac will report the signal strength from Port 1. The upper bar is controllable and can look at any of the three ports by making a port selection in the AcuTrac menu. The port selection signal from the AcuTrac to the switch is only sent when you initially select Port 1 or Port 2 or Port 3 with the arrowhead and press the "**ON/MENU**" button. Thereafter, if you power down the switch, or make any other changes, you may need to re-select the desired port in the menu and press the "**ON/MENU**" button again

The DishPro Plus hardware and technology necessitates the use of the DP receiver for external powering of the LNBF during alignment. This also assures effective functioning of the AcuTrac 22 meter and reasonably maintains an adequate internal battery capacity.

One of the following two wiring diagrams should be used to avoid overtaxing the battery supply capabilities of the AcuTrac 22. In either case, when using a DP receiver for power, you must go into the “22KHZ MODE” in the AcuTrac menu and select “OFF”. This will block the switching commands sent from the receiver.

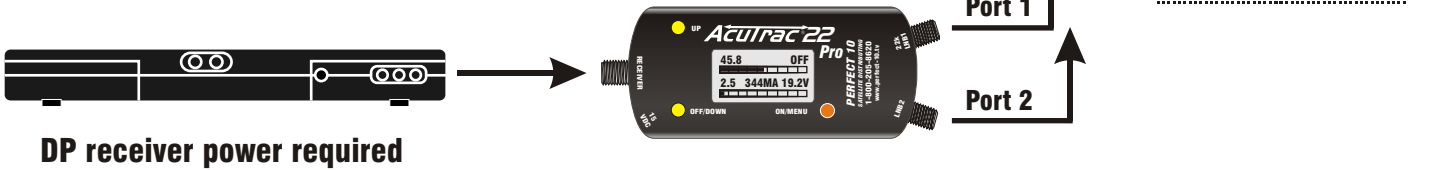

OR

In the diagram above, the DP receiver is supplying power through the AcuTrac; in the diagram at right, the power is supplied directly to the DishPro Plus LNBF and the internal battery of the AcuTrac is only providing power for the meter. Both methods will work.

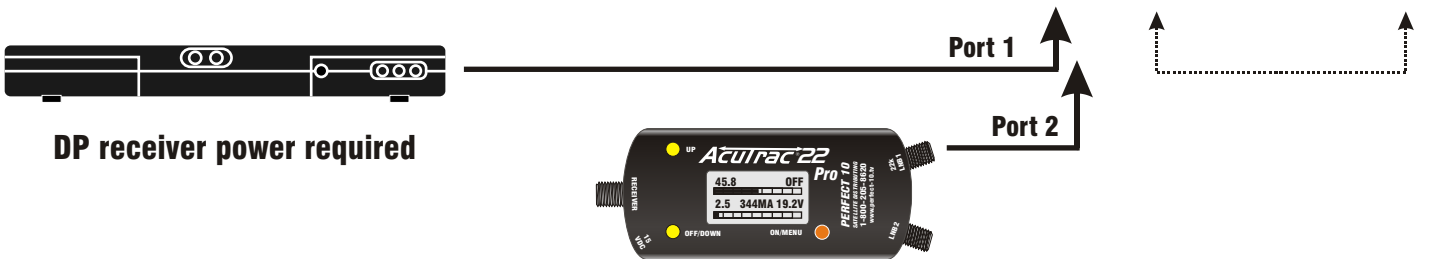

Use of the internal battery for powering the DishPro Plus LNBF will drain the battery very rapidly and may ultimately result in a short life span for the battery and/or premature failure of the meter itself; therefore it is not recommended.

Perfect 10 does not assume responsibility for meters functioning reliably with the DishPro or DishPro Plus hardware when attempting to use only the meter’s limited internal power supply for alignment of these systems.

Note that the DishPro Plus “SEPARATOR” should not be inserted into the wiring layout when aligning the antenna with the AcuTrac meter. It does not assist with alignment and may interfere with meter reception.

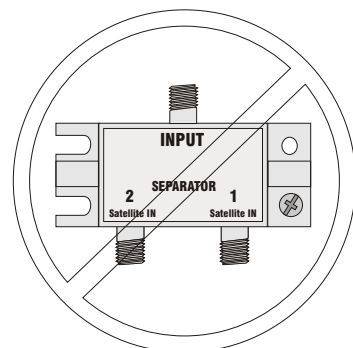

F.A.Q.s

Be aware of the fact that the AcuTrac 22 Pro is an AID to aligning the antenna, it does not identify which satellite you are looking at. It still takes basic knowledge of satellite elevation and azimuth to track and identify the correct satellite(s). You can easily pick the wrong satellite, align the antenna and then discover that the satellite receiver indicates NO SIGNAL.

The AcuTrac 22 Pro can be used with digital or analog LNBFs. It also operates with both circular and linear polarized LNBFs. The only qualification is that the LNBF must be down-converting to an I.F. Frequency of 900~2200 Mhz (which is typical of most LNBFs).

The AcuTrac22 Pro looks at the entire spectrum of signals received from the LNB and gives an overall summation of the signal. It is not transponder / frequency selectable. IF you need specific frequency selections, Perfect 10 offers the 'SatLook Digital' meter which can provide individual transponder information.

There is not an exact number meter reading which you should attempt to achieve. Your objective is to MAXIMIZE the meter reading so that the antenna and LNBFs are providing the best signal possible.

The signal level reading indicated on the AcuTrac 22 Pro will NOT be the same reading as you get on the satellite receiver. These two readings can compliment each other (when one increases, the other increases) but the numbers will not be the same. The sat receiver indicates interpreted data reception (forward error correction info) while the AcuTrac 22 Pro indicates overall gain of the LNBFs.

The AcuTrac 22 Pro can be confused by weak (satellite frequency) signals reflected from the LNBF if these weak signals strike a tree or building and are reflected back into the dish. When trees are in the path of the satellite signal, you may need to fall back on the satellite receiver for correct dish alignment.

Battery performance time is GREATLY affected by cold air temperatures. This is just a fact of life for batteries. In freezing conditions battery packs can lose more than 60% of their capacity. **To avoid cold battery problems, keep the AcuTrac Pro in your (inside) shirt pocket until time to use it.**

Some LNBF switches can interfere with proper operation of this device. The AcuTrac 22Pro is designed to control DirecTV and DishPro devices. Switches that require other methods of signal selection may have to be bypassed. Some antennas have these devices located in the mounting area of the LNBFs. To alleviate this situation, it may be necessary to carry an extra mounting bracket with standard LNBFs attached. Temporarily utilize this extra bracket until alignment is completed..

The AcuTrac 22 Pro is designed to align satellite antennas. It will not aid in the alignment of off-air antennas.

The internal battery charger in this meter (activated by the wall power supply or vehicle charger cord) takes 14 hour to fully charge a dead battery. The circuit has a built-in voltage detector which will prevent overcharging a partially charged battery. The internal charger circuit does not "trickle charge" so it serves no purpose to leave the AcuTrac Pro continually plugged into either power source. **When fully charged, the AcuTrac22 Pro can power one LNBF at 13 V (default voltage) for about one hour or the Phase III LNBF assembly for about 30 minutes.**

The 18V optional setting (see page 3 "13/18V") is selectable only when running from the internal battery. Keep in mind that this synthesized higher voltage requires quite a bit more power from the internal 8.4 volt NiMH battery. Use the higher voltage ONLY if it is necessary as your battery run time will be reduced.

The AcuTrac22 Pro is warranted for one full year against manufacturing defects. We will ask for proof of purchase so KEEP YOUR RECEIPT.

***Perfect 10 Satellite Distributing
3901 Progress St.
North Little Rock, AR 72114***

1-800-205-8620

MORE GREAT ALIGNMENT EQUIPMENT FROM PERFECT 10

LOW COST SATLOOK DIGITAL

Industry's Best Value!

SPECTRUM ANALYZER

PROS GET IT RIGHT
THE FIRST TIME
WITH THIS
EASY-TO-USE
DIGITAL
SPECTRUM
ANALYZER



#SATLOOKDIG

Only
\$899⁹⁹
Each

**BUY 2
SAVE
\$100**

- 1 Year Warranty
- AC/DC Battery Operated
- Carrying Case included

SATLOOK DIGITAL SPECIFICATIONS

- FREQUENCY RANGE: 920-2150 MHZ
- PRESENTATION: 4.5" B&W SCREEN AND 64X128 PIX LCD
- SPECTRUM: FULL & EXPANSION TO 250 MHZ (10 MHZ STEP)
- TUNING INDICATION: FREQUENCY IN MHZ
- UNIT OF MEASURES: dBuV, dBmV, dBm
- MEASUREMENT ACCURACY: +/- 2 dB
- MEASUREMENT: DIGITAL & ANALOG SATLEVEL IN dB
DIGITAL C/N RATIO IN dB
DVB QPSK BER, BIT ERROR RATIO
DVB QPSK CONSTELLATION SHEET
ANALOG FM DEMODULATION FROM 5.5-8.5MHZ
ANALOGTV-PICTURE (PAL/NTSC/SECAM)
- AUDIO: 22KHZ, DISEQC 1.0-1.2, 13/18 V
- PICTURE: RS232 FOR PC COMMUNICATION (UP/DOWNLOAD)
- GENERATOR: 3X100 BANKS FOR SPECTRUM AND FREQUENCY
- AUXILIARY OUTPUTS: 1-2 HOUR-INTERNAL BATTERY W/BUILT IN AC CHARGER
- MEMORY: 1-2 HOUR-INTERNAL BATTERY W/BUILT IN AC CHARGER
- OPERATIONAL TIME: 1-2 HOUR-INTERNAL BATTERY W/BUILT IN AC CHARGER

DIGISAT III PRO MULTIMETER

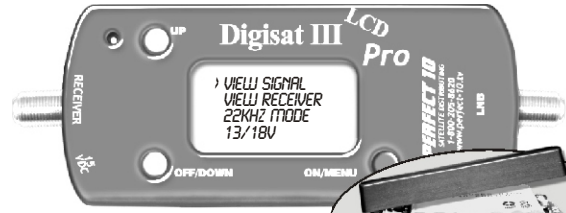

DIGISAT III PRO INCLUDES
THE FOLLOWING
ACCESSORIES



NOW WITH SELF-CONTAINED
NICKEL HYDRIDE BATTERIES
PLUS A 1 YEAR WARRANTY



INCLUDES:

- Self-Contained Rechargeable Battery
- Digital LCD Display
- Multi-Function Menu Driven
- Align Antenna Quickly & Reliably without Receiver Hook-up
- Switches 22 KHz On/Off
- No More Plugging & Unplugging
- Battery Pack
- Works with All LNBFs
- AC Charger Included
- DC Charger Included
- 6 Foot Coax Included with 2 Quick F-Connectors
- Includes Accessories Pack
- 13/18 Volt Switching
- DISH PRO Switching
- Plus 1 YEAR WARRANTY

DIGITAL LCD
DISPLAY
MULTI-FUNCTION
MENU DRIVEN

As Low As
\$89⁹⁹
10+

#DG3PRO

Qty	Price
1-3	\$94.99
4-9	\$92.99
10+	\$89.99

**ALIGN ANTENNAS
QUICKLY & RELIABLY!**

LOW COST

SATLOOK MARK III SPECTRUM ANALYZER

PLASTIC PRINTS
FIT SATLOOK'S SCREEN
TO HELP LOCK ONTO
YOUR TARGET!

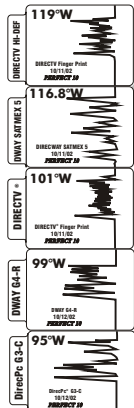

SATLOOK MARK III FEATURE PACK

- For DIRECWAY, DIRECTV & C-Band
- Extended Frequency Range 950~2150 MHZ
- Improved Battery Life
- AC-DC Battery Operation
- Leatherette Case
- A.C. Charger
- D.C. Charger
- Full Operating Instructions

#SATLOOKKIT

As Low As
\$499⁹⁹
10+ Lot

Qty	Price
1-3	\$549.99
4-9	\$529.99
10+	\$499.99



ALIGNMENT TOOLS

HANDY & USEFUL PRODUCTS
FROM PERFECT 10 ENGINEERING

SAT BEEPER

SATBEEPERKIT
INCLUDES
3' COAX
W/ F- CONNECTORS
ATTACHED

Qty	Price
1-3	\$10.99
4-9	\$10.49
10-49	\$ 9.99
50+	\$ 9.49

SQUAWKER & ALIGNMENT INDICATOR

Qty	Price
1-3	\$ 9.99
4-9	\$ 9.49
10-49	\$ 8.99
50+	\$ 8.49



As Low As
\$9⁴⁹
50+ Lot

As Low As
\$8⁴⁹
50+ Lot

CALL 1-800-205-8620
SHOP ONLINE perfect-10.tv